

Production Worksheet

Wilcom EmbroideryStudio - Designing



Design: **3**

Title:

Stitches: 8,429
 Height: 3.51 in
 Width: 3.12 in
 Colors: 1
 Colorway: Colorway 1
 Zoom: 1:1

Machine format: Tajima
 Color changes: 0
 Stops: 1
 Trims: 44
 Appliqués: 0
 Left: 46.1 mm
 Right: 33.0 mm
 Up: 54.4 mm
 Down: 34.8 mm
 EndX: 0.00 in
 EndY: 0.00 in
 Area: 10.94 in²
 Max stitch: 6.8 mm
 Min stitch: 0.0 mm
 Max jump: 6.8 mm
 Total thread: 98.97ft
 Total bobbin: 25.68ft

Stop Sequence:

#	N#	Color	St.	Code	Name	Chart
1.	8	█	8,427	8	Black	Default

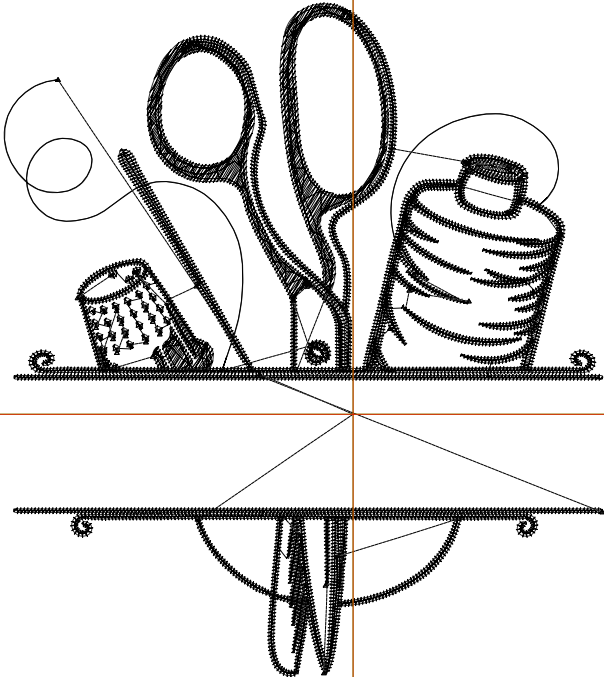

Production Worksheet

Wilcom EmbroideryStudio - Designing



Design: **4**

Title:

Stitches: 10,807
 Height: 4.51 in
 Width: 4.01 in
 Colors: 1
 Colorway: Colorway 1
 Zoom: 1:1

Machine format: Tajima
 Color changes: 0
 Stops: 1
 Trims: 53
 Appliqués: 0
 Left: 57.4 mm
 Right: 44.4 mm
 Up: 67.1 mm
 Down: 47.5 mm
 EndX: 0.00 in
 EndY: 0.00 in
 Area: 18.07 in²
 Max stitch: 6.6 mm
 Min stitch: 0.0 mm
 Max jump: 6.6 mm
 Total thread: 134.20ft
 Total bobbin: 37.31ft

Stop Sequence:

#	N#	Color	St.	Code	Name	Chart
1.	8	█	10,805	8	Black	Default

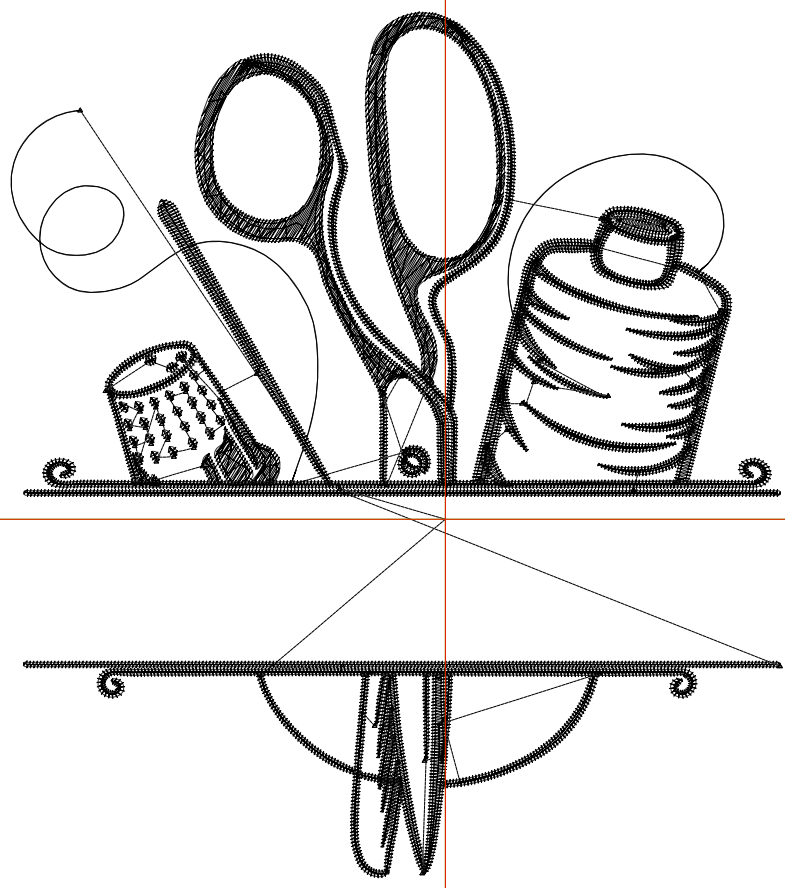

Production Worksheet

Wilcom EmbroideryStudio - Designing



Design: **5**

Title:

Stitches: 13,245
 Height: 5.51 in
 Width: 4.90 in
 Colors: 1
 Colorway: Colorway 1
 Zoom: 1:1

Machine format: Tajima
 Color changes: 0
 Stops: 1
 Trims: 63
 Appliqués: 0
 Left: 68.7 mm
 Right: 55.7 mm
 Up: 79.8 mm
 Down: 60.2 mm
 EndX: 0.00 in
 EndY: 0.00 in
 Area: 26.99 in²
 Max stitch: 6.9 mm
 Min stitch: 0.0 mm
 Max jump: 6.9 mm
 Total thread: 172.93ft
 Total bobbin: 50.78ft

Stop Sequence:

#	N#	Color	St.	Code	Name	Chart
1.	8	█	13,243	8	Black	Default

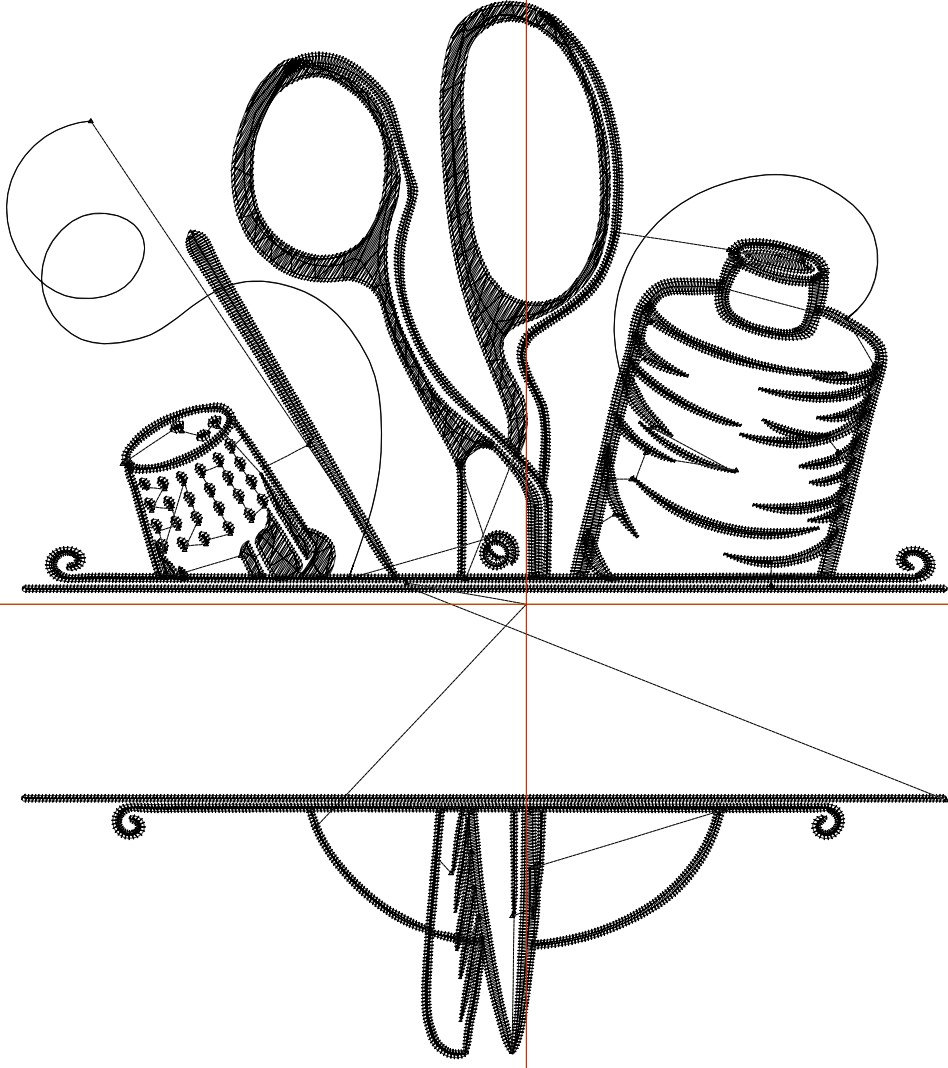

Production Worksheet

Wilcom EmbroideryStudio - Designing



Design: **6**

Title:

Stitches: 15,792
Height: 6.51 in
Width: 5.79 in
Colors: 1
Colorway: Colorway 1
Zoom: 1:1

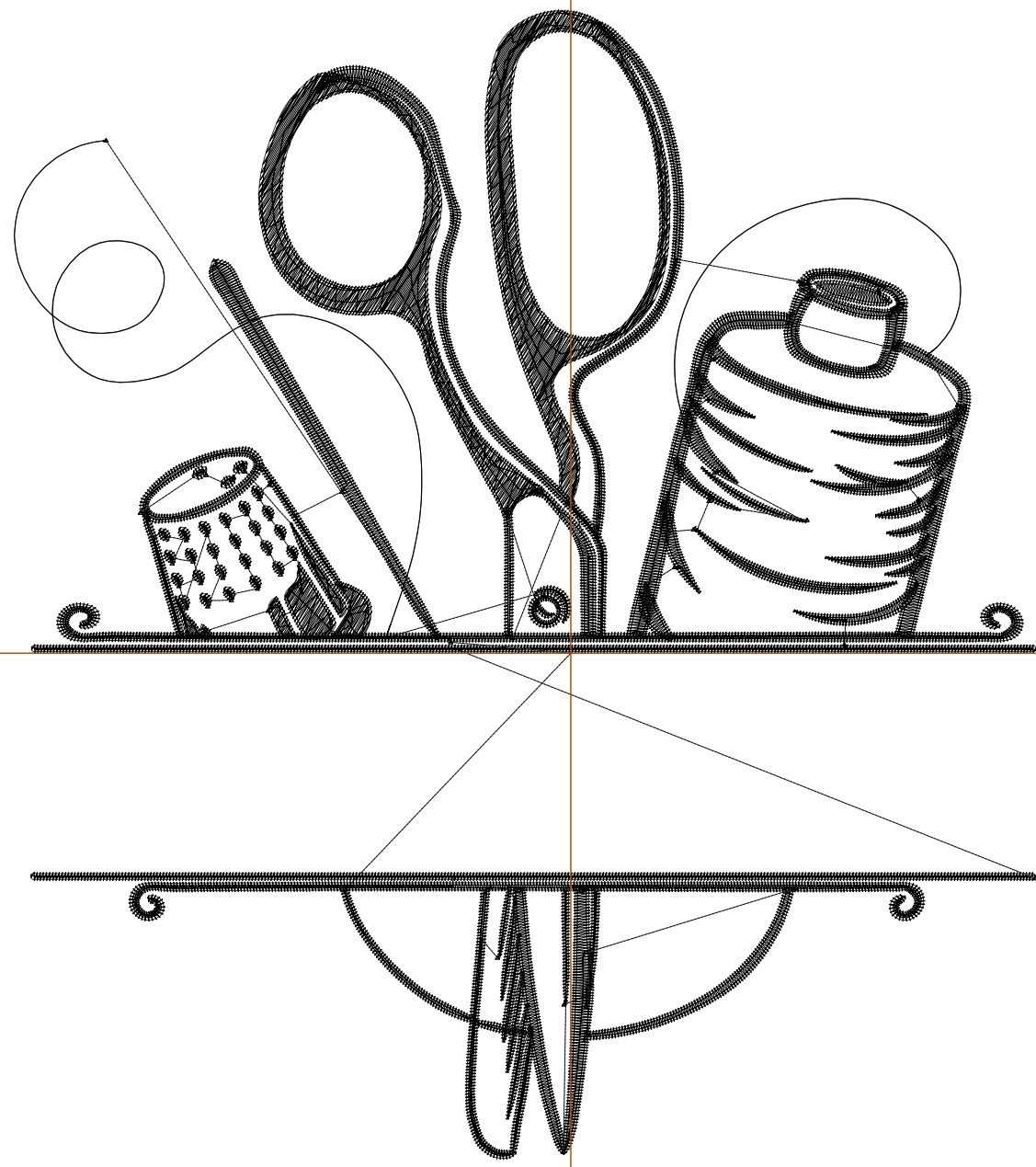

Production Worksheet

Wilcom EmbroideryStudio - Designing



Design: **6**

Title:

Stitches: 15,792
Height: 6.51 in
Width: 5.79 in
Colors: 1
Colorway: Colorway 1
Zoom: 1:1

Machine format: Tajima
Color changes: 0
Stops: 1
Trims: 67
Appliqués: 0
Left: 80.1 mm
Right: 67.0 mm
Up: 92.5 mm
Down: 72.9 mm
EndX: 0.00 in
EndY: 0.00 in
Area 37.69 in²
Max stitch: 7.0 mm
Min stitch: 0.0 mm
Max jump: 7.0 mm
Total thread: 216.62ft
Total bobbin: 66.77ft

Stop Sequence:

#	N#	Color	St.	Code	Name	Chart
1.	8	█	15,790	8	Black	Default

Production Worksheet

Wilcom EmbroideryStudio - Designing



Design: **7**

Title:

Stitches: 18,151
Height: 7.51 in
Width: 6.68 in
Colors: 1
Colorway: Colorway 1
Zoom: 1:1

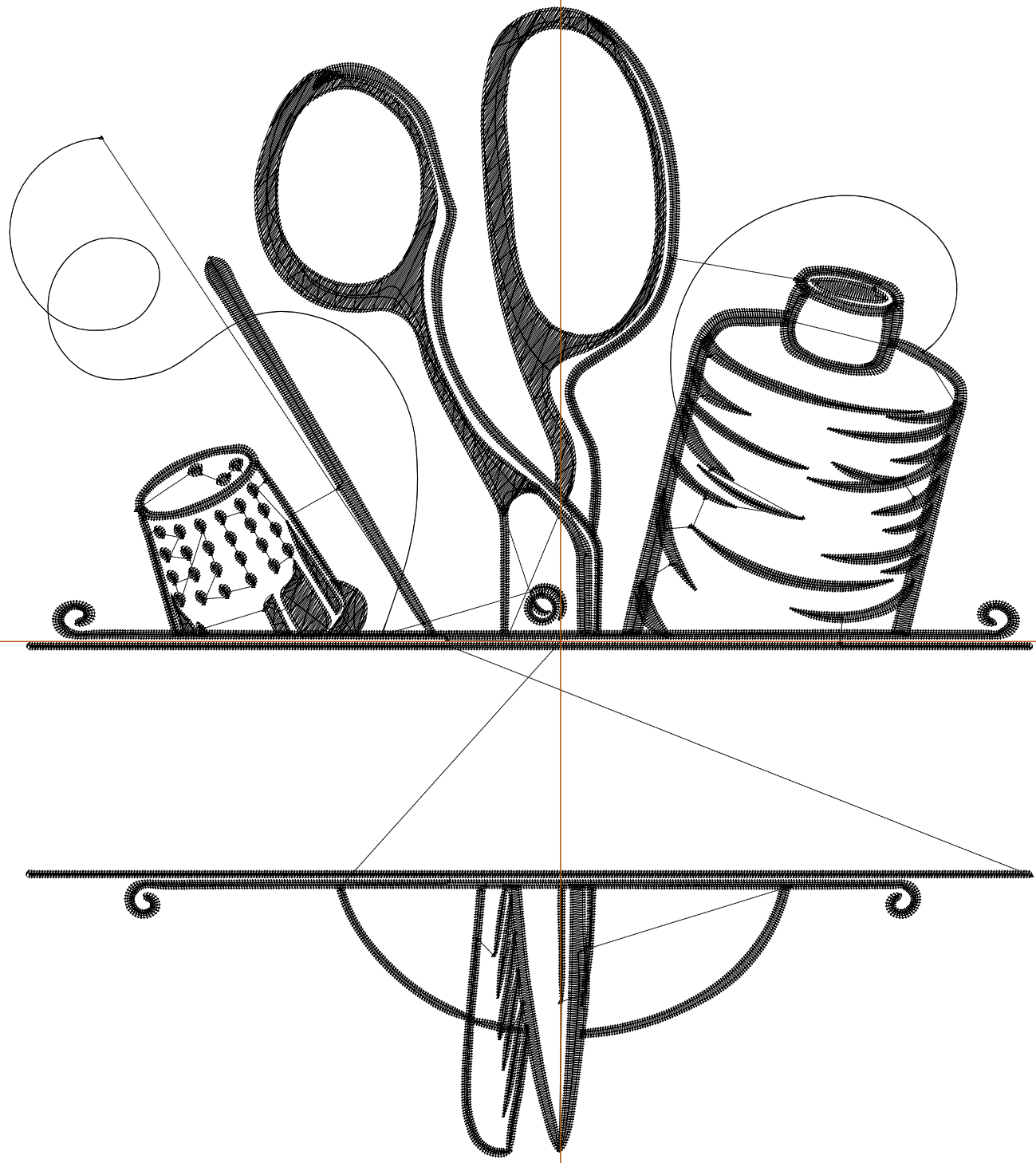

Production Worksheet

Wilcom EmbroideryStudio - Designing



Design: **7**

Title:

Stitches: 18,151
Height: 7.51 in
Width: 6.68 in
Colors: 1
Colorway: Colorway 1
Zoom: 1:1

Machine format: Tajima
Color changes: 0
Stops: 1
Trims: 67
Appliqués: 0
Left: 91.4 mm
Right: 78.3 mm
Up: 105.2 mm
Down: 85.6 mm
EndX: 0.00 in
EndY: 0.00 in
Area 50.17 in²
Max stitch: 7.0 mm
Min stitch: 0.0 mm
Max jump: 7.0 mm
Total thread: 261.44ft
Total bobbin: 84.16ft

Stop Sequence:

#	N#	Color	St.	Code	Name	Chart
1.	8	█	18,149	8	Black	Default